

Erklaget

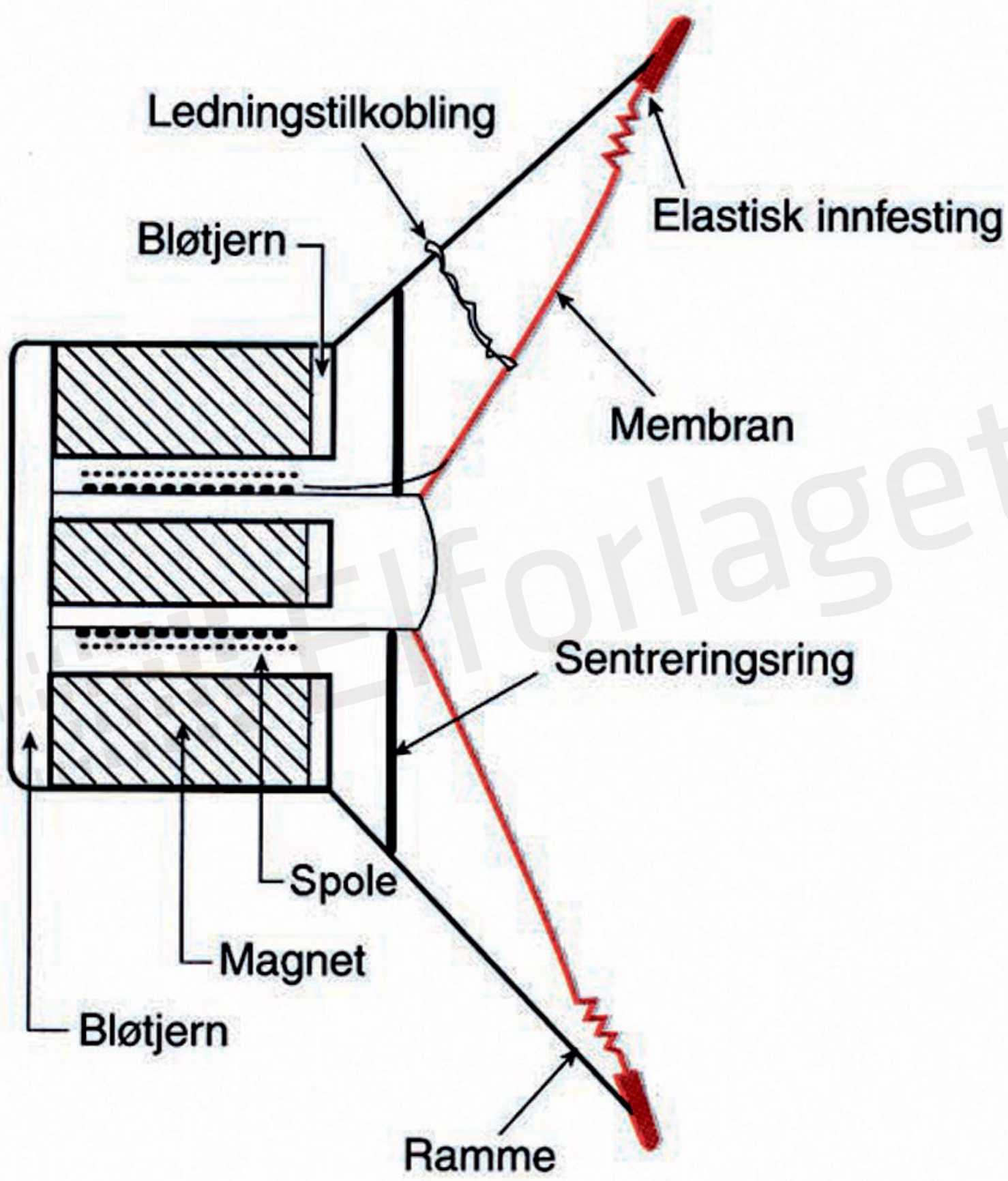

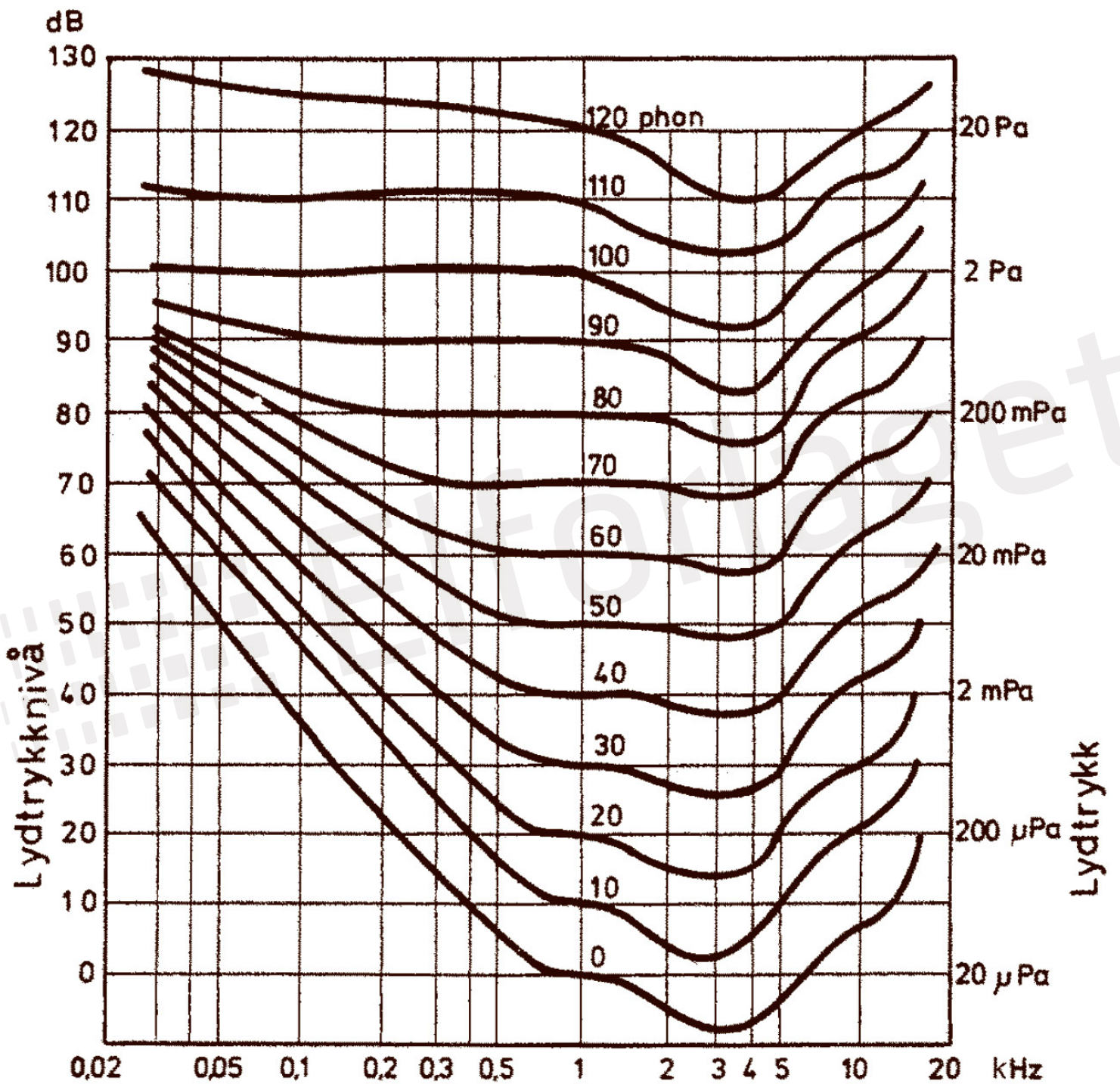





Fra
forsterker

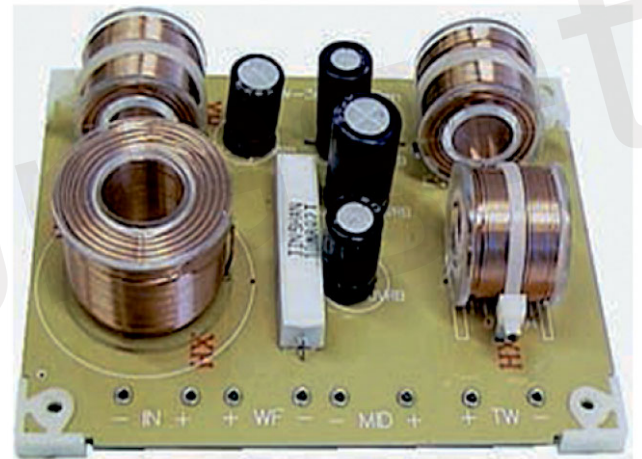
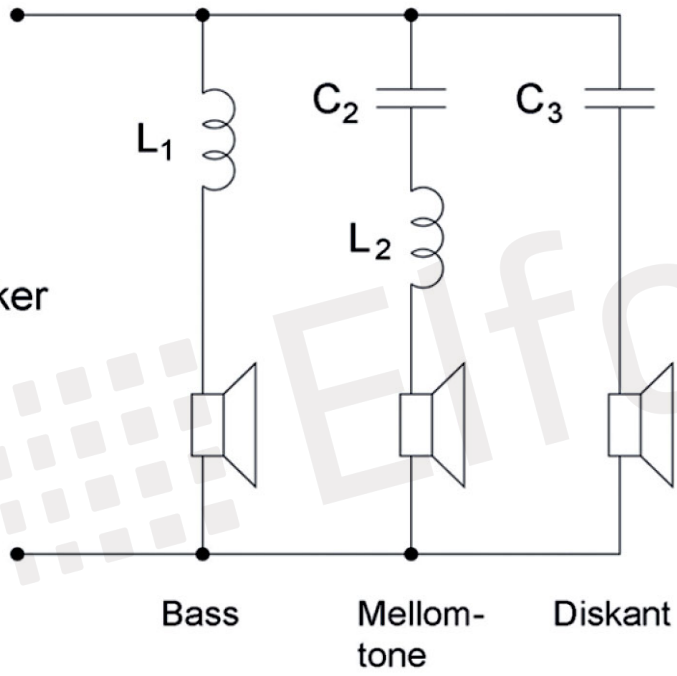

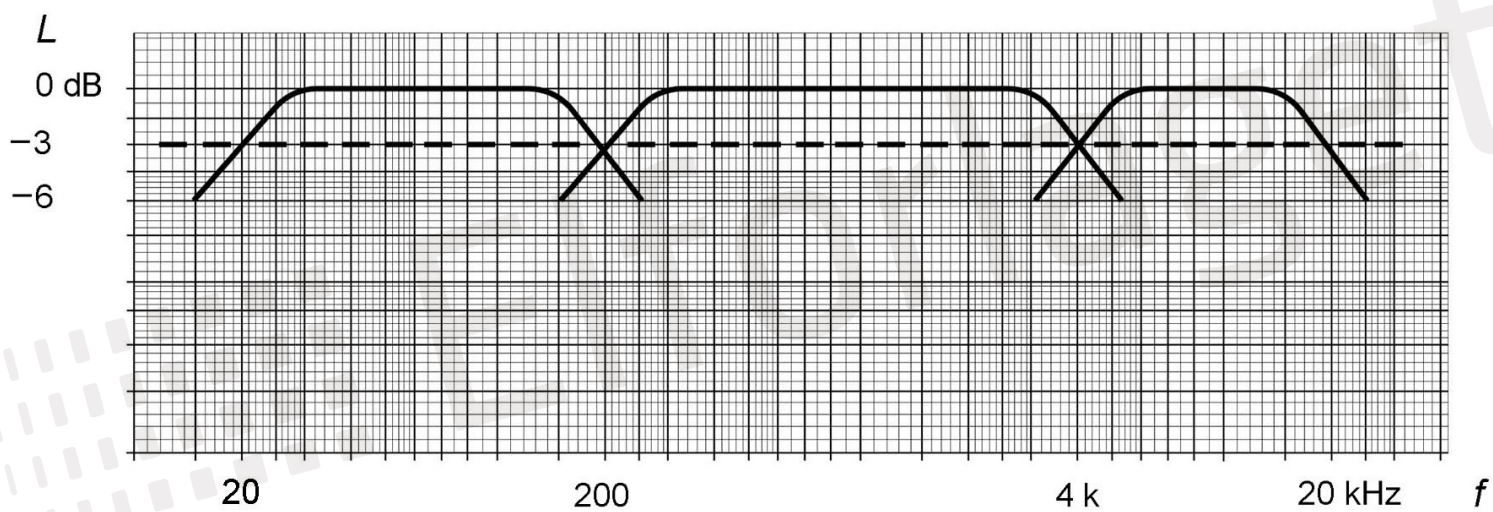











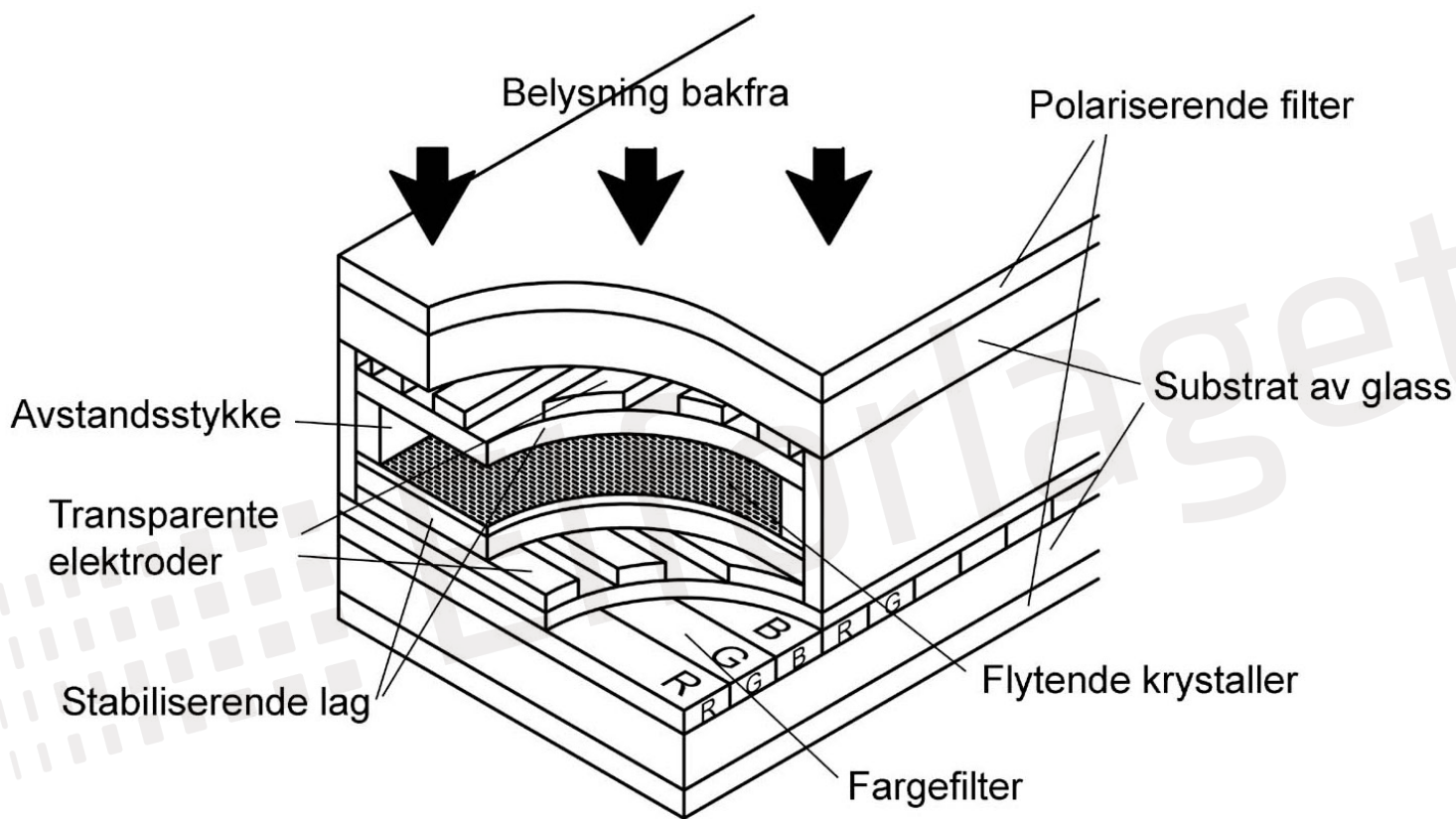



Full HD
1080p
MPEG4

SAMSUNG



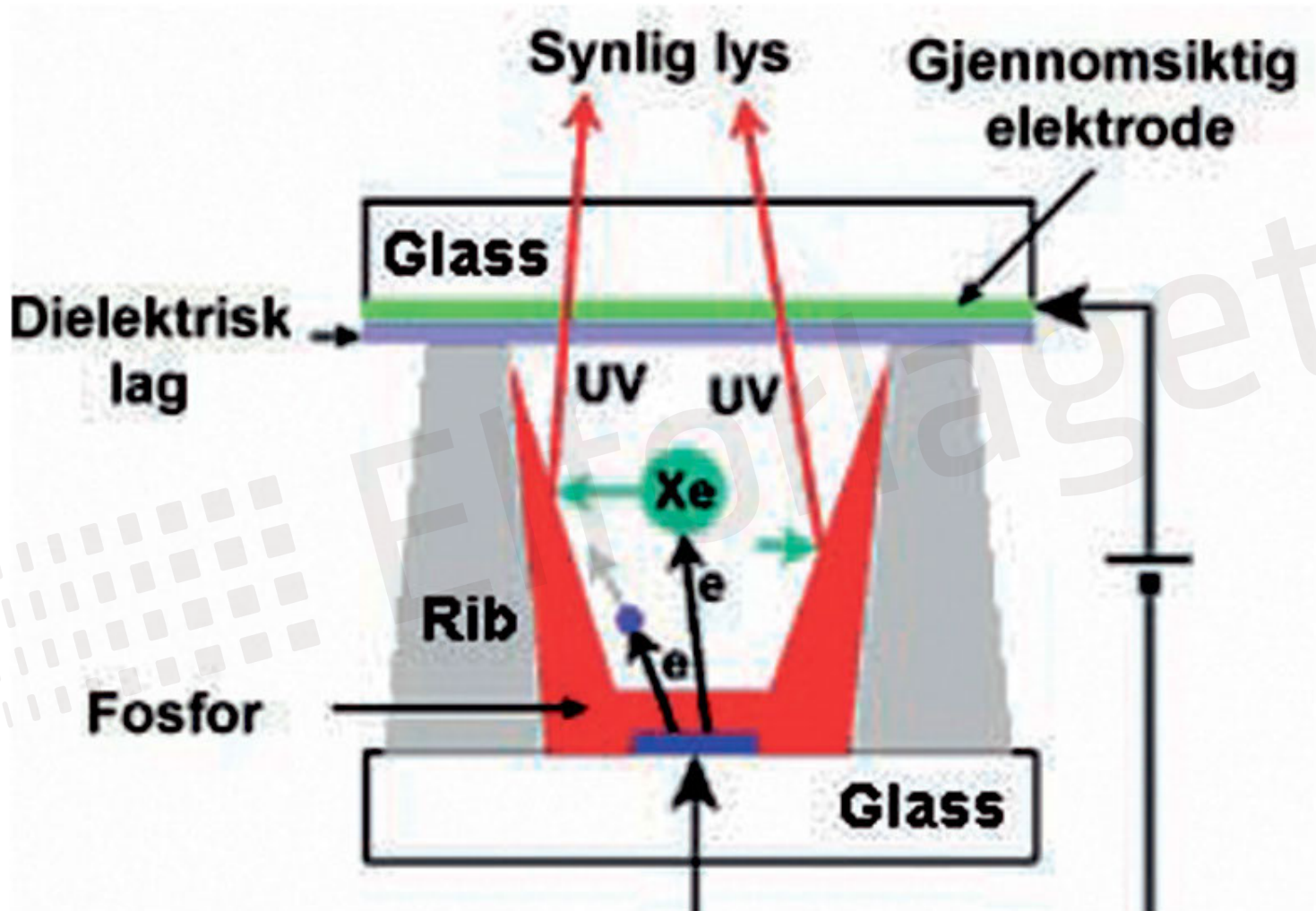





Full HD
1080p
MPEG4

SAMSUNG





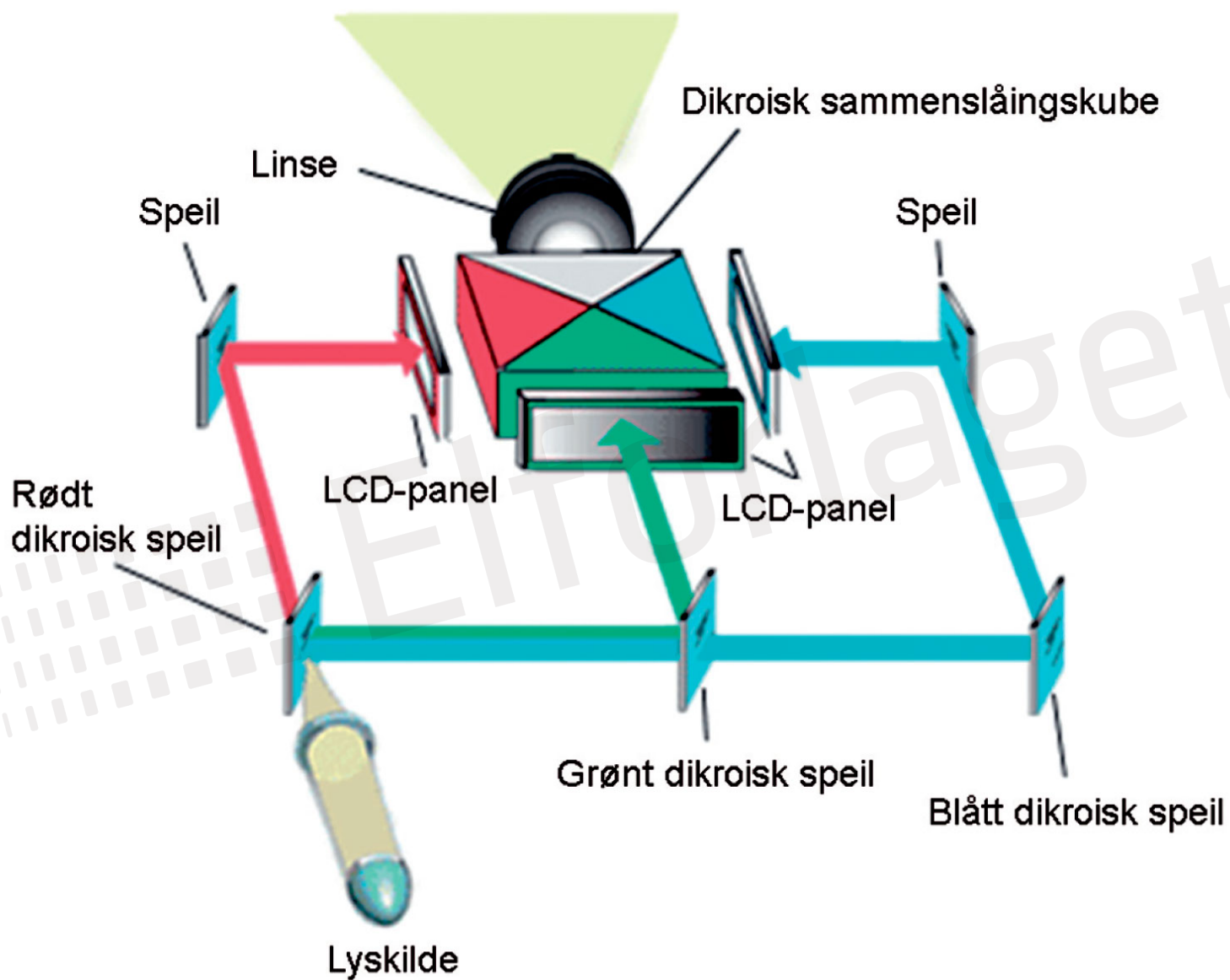



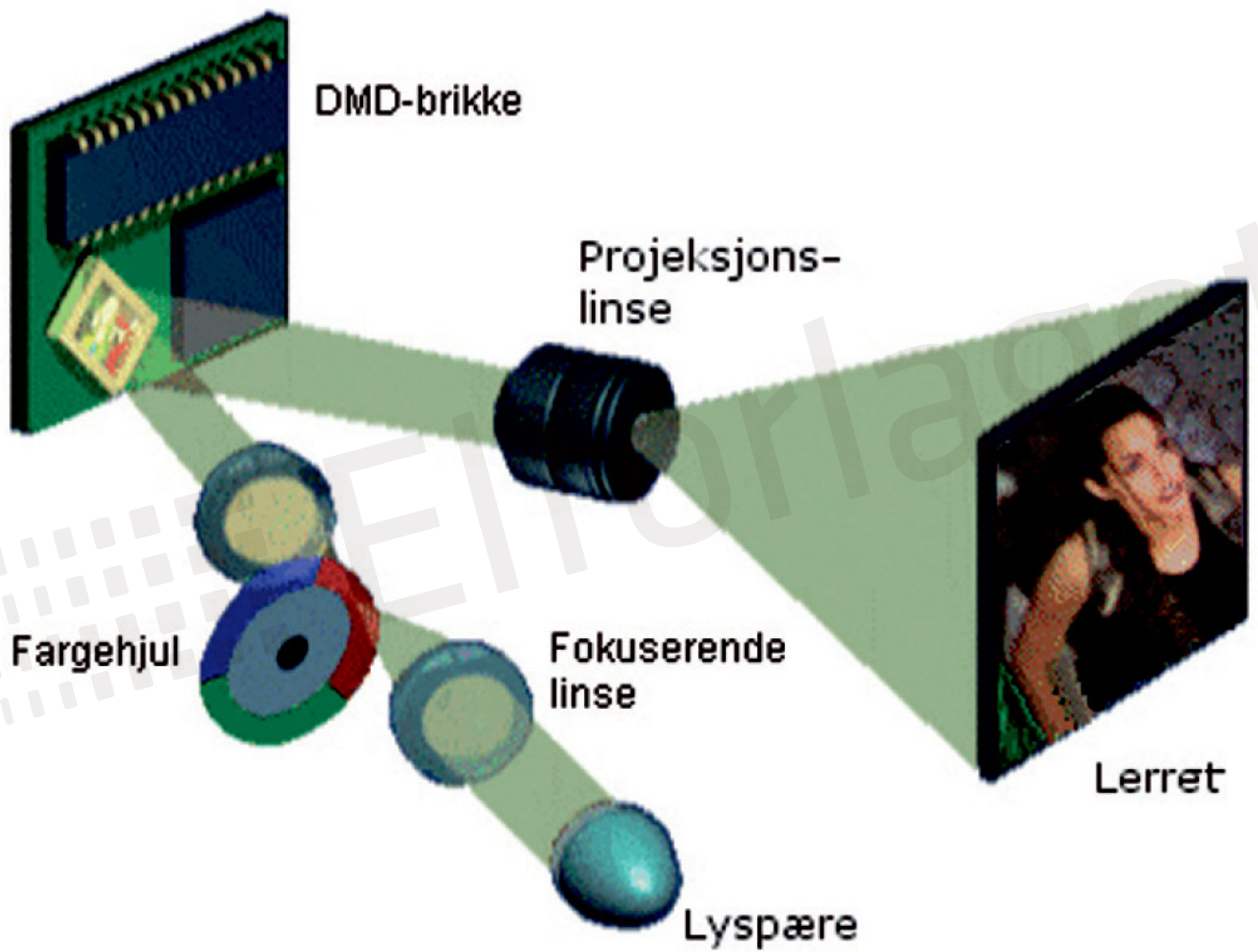



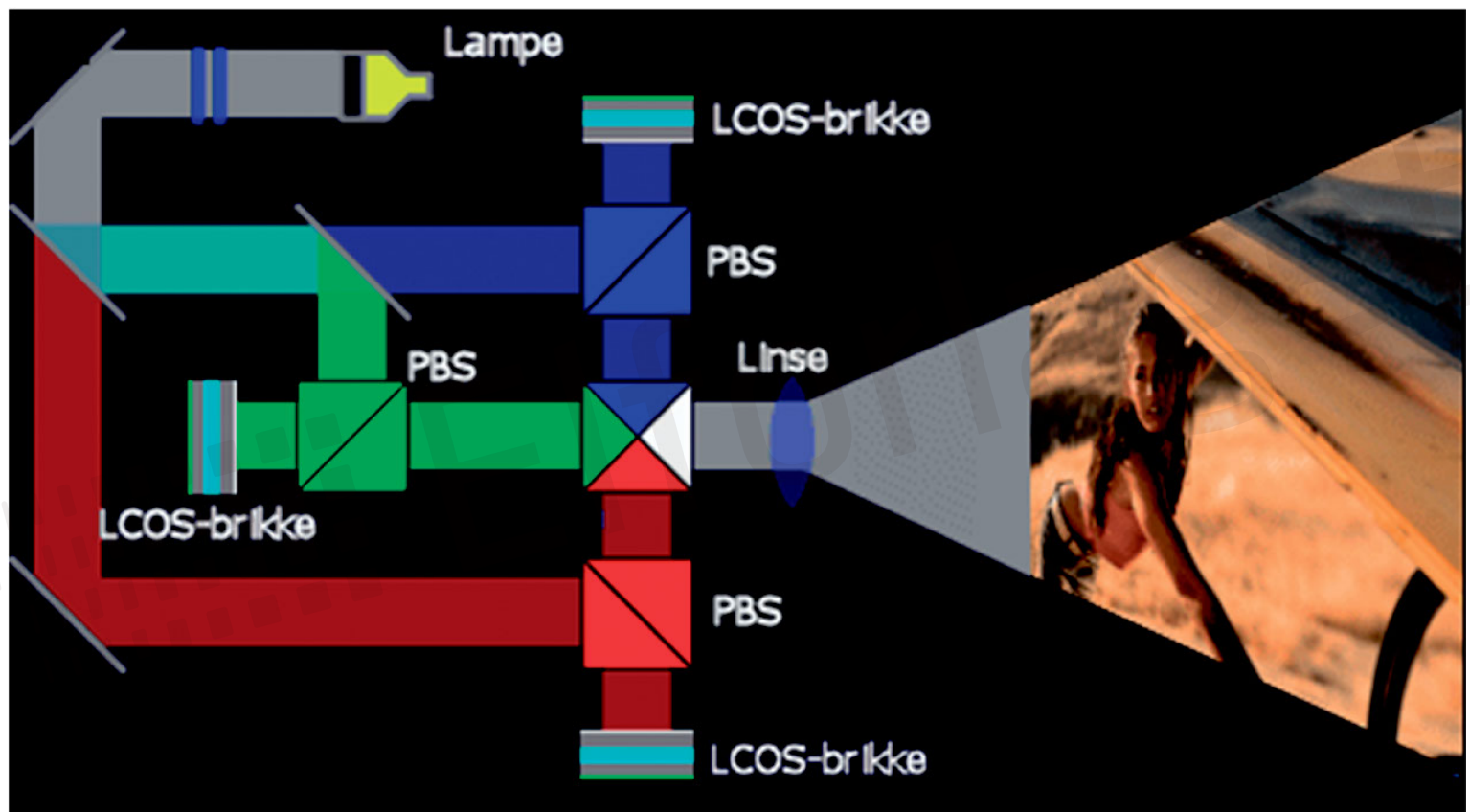

Elforlaget









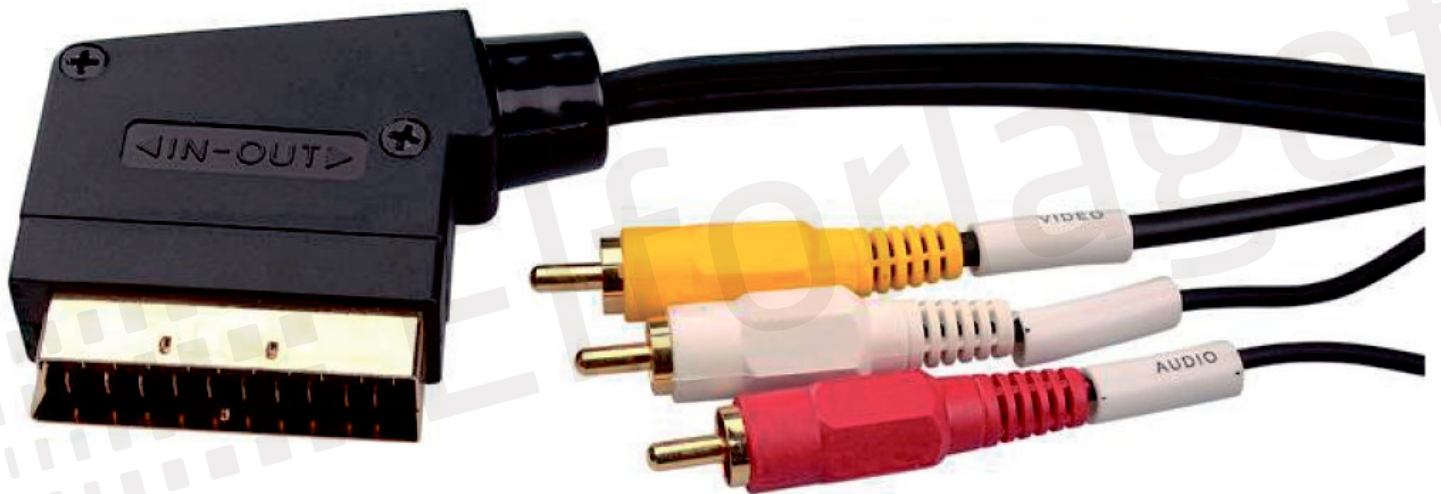





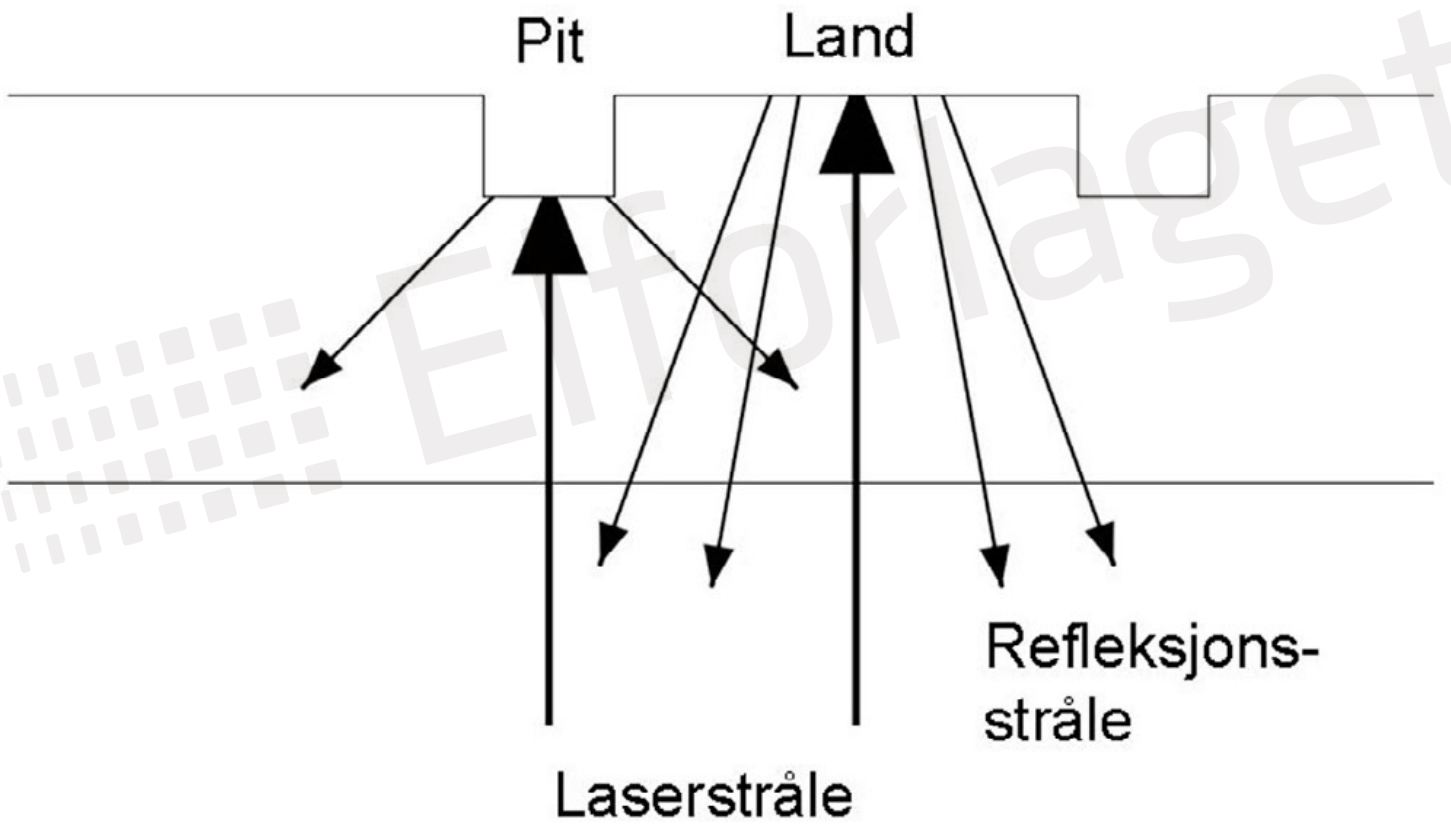







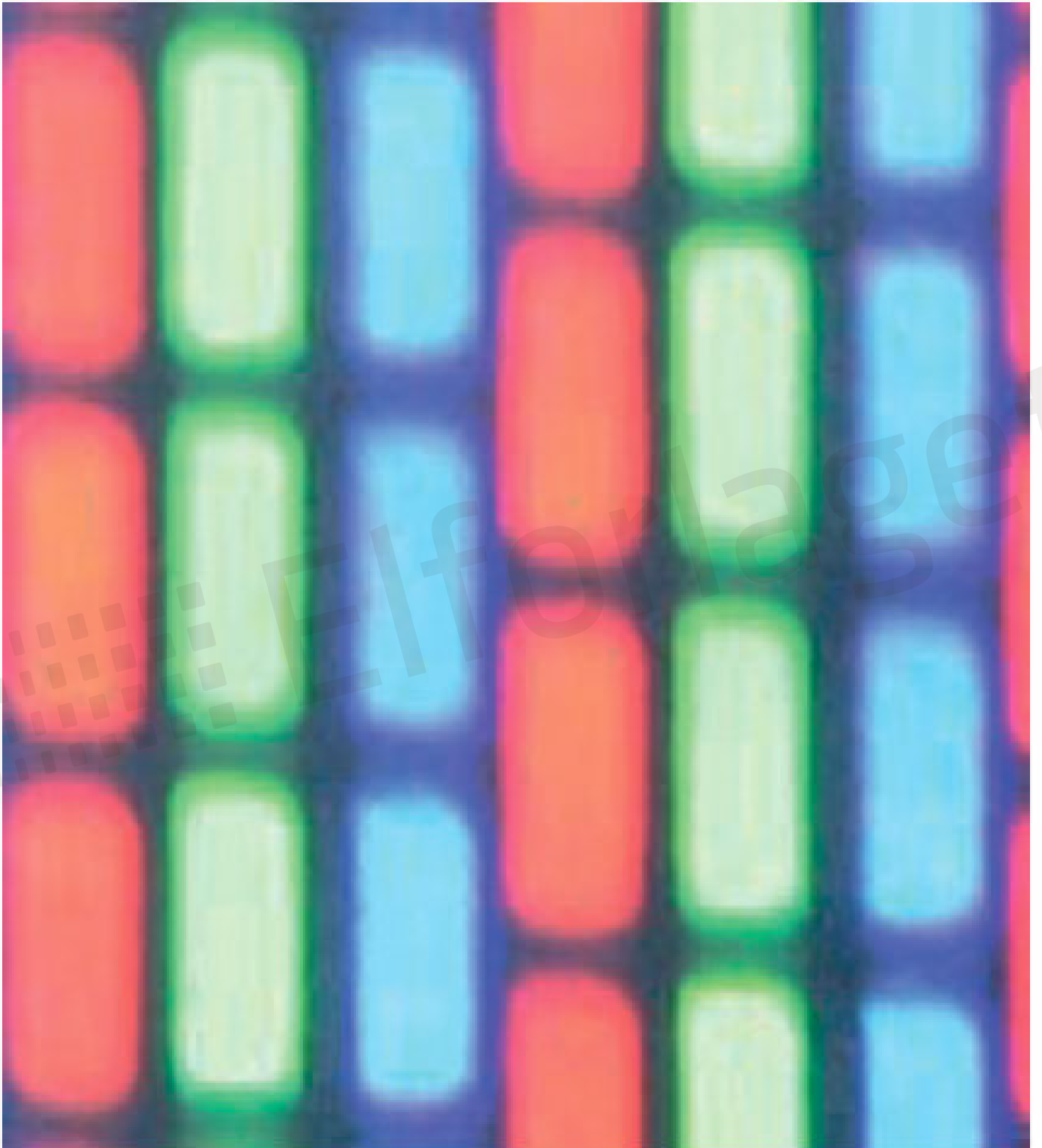





Blu-ray Disc

Blu-ray laserlys 405 nm

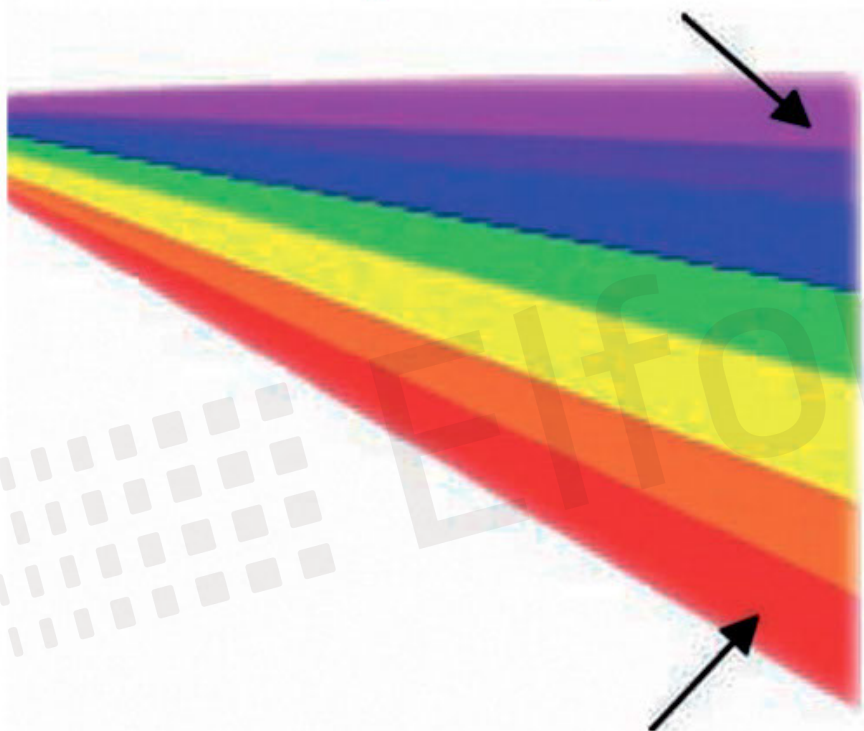

Fiolett 400 nm
Indigo 445 nm
Blå 475 nm
Grønn 510 nm
Gul 570 nm
Oransje 590 nm
Rød 650 nm

DVD laserlys 650 nm

Blu-ray vs. DVD Capacity

Single-layer DVD



Single-layer Blu-ray disc



Double-layer Blu-ray disc

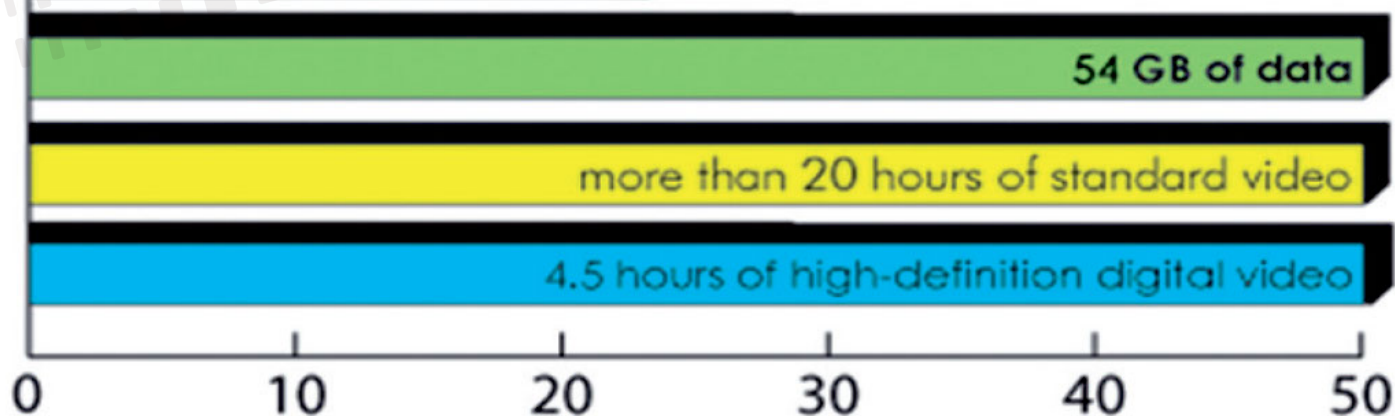

CD

780 nm rød laser
Blenderåpning 0,45

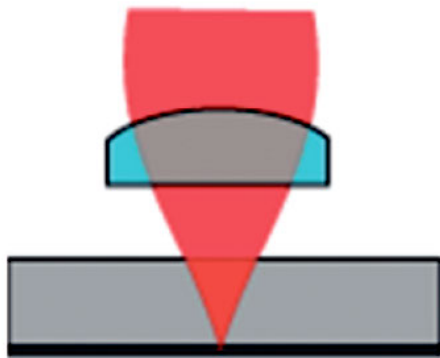

Ett lag 1,2 mm av
polykarbonat

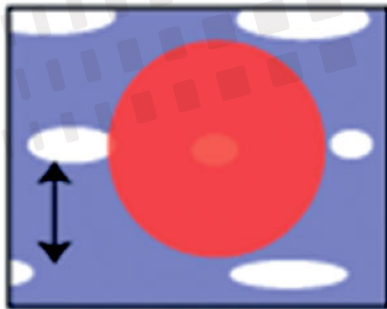

Sporavstand 1,6 μm

DVD

650 nm rød laser
Blenderåpning 0,6

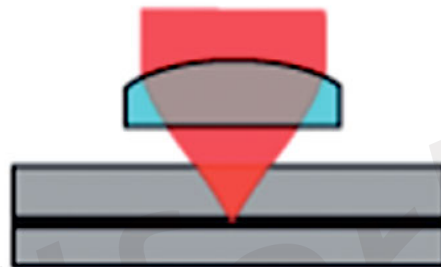

To lag 0,6 mm av
polykarbonat

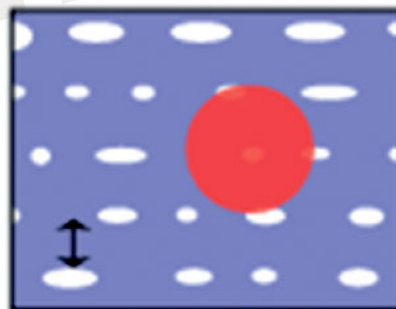

Sporavstand 0,74 μm

BD

405 nm blå laser
Blenderåpning 0,8

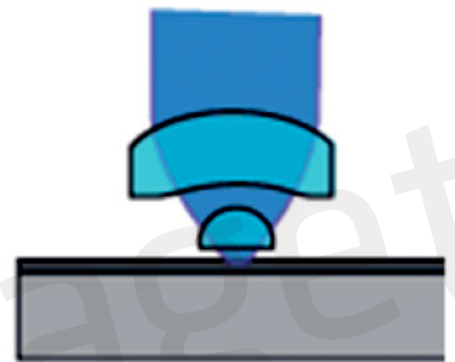

Ett lag 1,1 mm av
polykarbonat

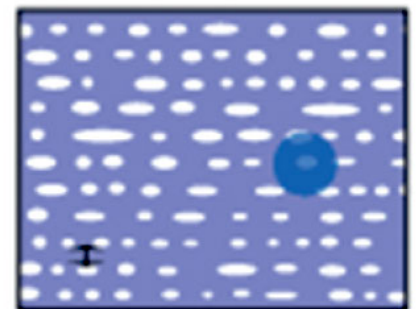

Sporavstand 0,30 μm





